

8 7 6 5 4 3 2 1

D

D

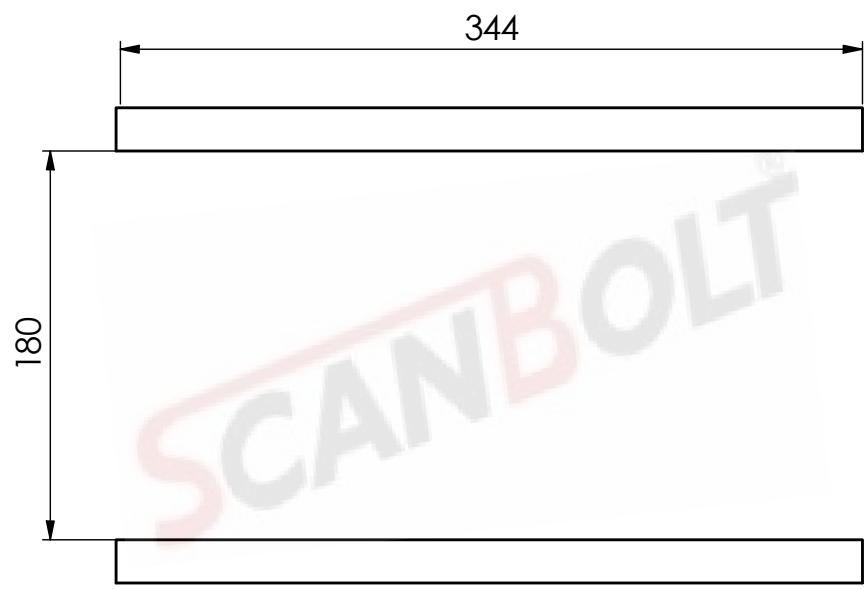
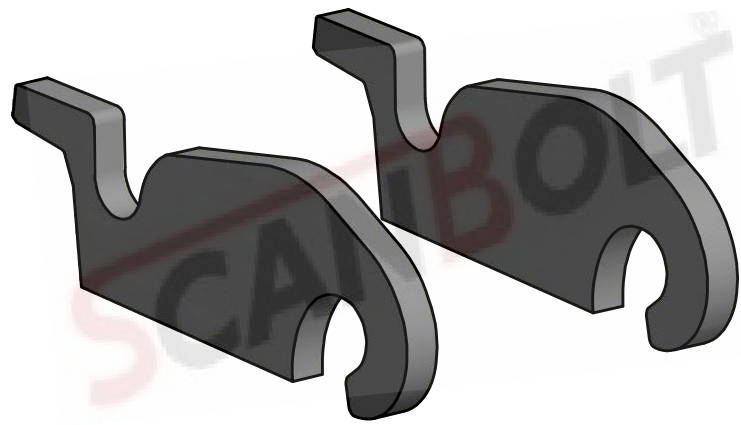

C

C



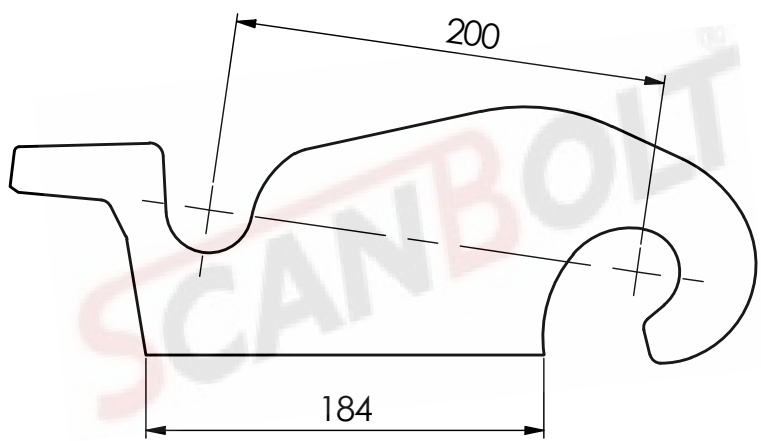
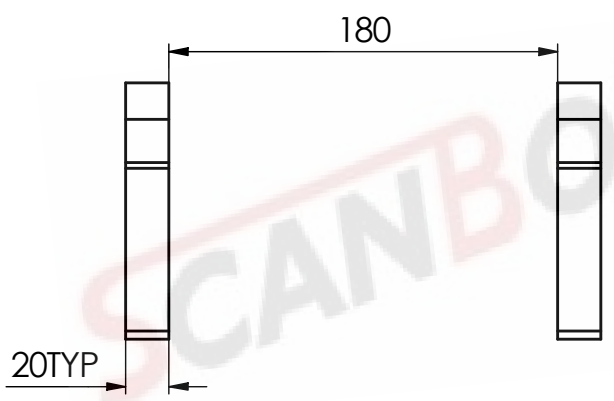

B

B



A

A

MATERIAL SPECIFICATION	
	ST52.3
	EN8D
	HB 400
	HB 450
	CASTALLOY STEEL

SCANBOLT®	
DESCRIPTION	CW05 HANGER
MACHINE CLASS	0.5-3.4 TON
WEIGHT	8 KG
HEAPED CAPACITY	

8 7 6 5 4 3 2 1